

DENTAL CHAIR

— MET·DU-30 PRO





Technical Specifications

1. Breaking through the traditional sheet metal structure, we adopt a square tube combination design, which has high torsional stiffness and a more stable structure.
2. Fully injection-molded parts use ABS as the main material, which offers good antioxidant and anti-yellowing properties.
3. The 120° rotatable side box design provides operating space for treatment.
4. Adjustable color temperature LED sensor lights ensure an optimal light environment and health safety during treatment.
5. The memory seat adjustment function facilitates the dentist's treatment operations.

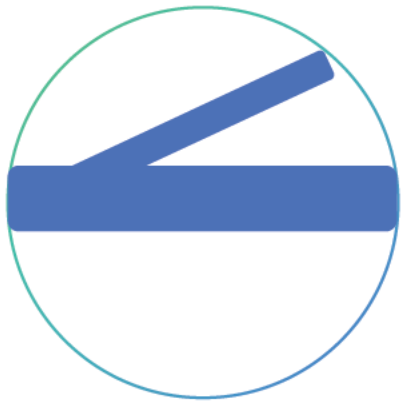

Safe usage radius range:

Working Conditions

Power supply: AC220V/AC110V 50/60HZ

Input power: 1200W

Working air pressure: 0.5-0.8Mpa,

Working water pressure: 0.2-0.3Mpa

Fuse specification: RFI-20.

Specification: $\Phi 5 \times 20$.

Rated current: 6.0A

DC motor: DC24V/L3.8A

Configuration List

3-way syringe(cold/hot)	2sets	Dental light	1set
High speed handpiece tube	1set	Warm water system	1set
Low speedhandpiece tube	1set	Pure water supply system	1set
Low speedhandpiece tube	1set	Multifunction foot pedal	1set
Weaksuction tube	1set	DC 24V motor driven chair	1set
Dentist Stool	1set	Multifunctional assisant device	1set
Nine memory system	1set	/	/



Customizable Seating Options

PU / Real leather Color



* Of course, we can provide any color you desire.



Optional Lighting Configurations



D01



D02



D03



D04



D05

* The above lighting fixtures can be customized and replaced according to your needs.

Optional Configuration



Oral Camera



X-Ray

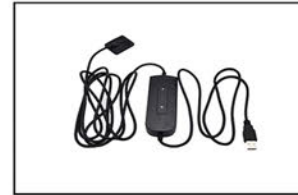

X-Ray Sensor



Top-Mounted



L-A MDS-A



Suction Valve



Handpic Kit



Tissue Box



Ultrasonic Scaler



L-A HS-6

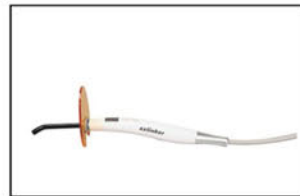

Light Cure



Electric Motor



Fibe Optic



Teeth Whitening



L-A HR3



Microscope



Dental Lamp



Suction Unit



Air compressor



L-A G

Installation Space

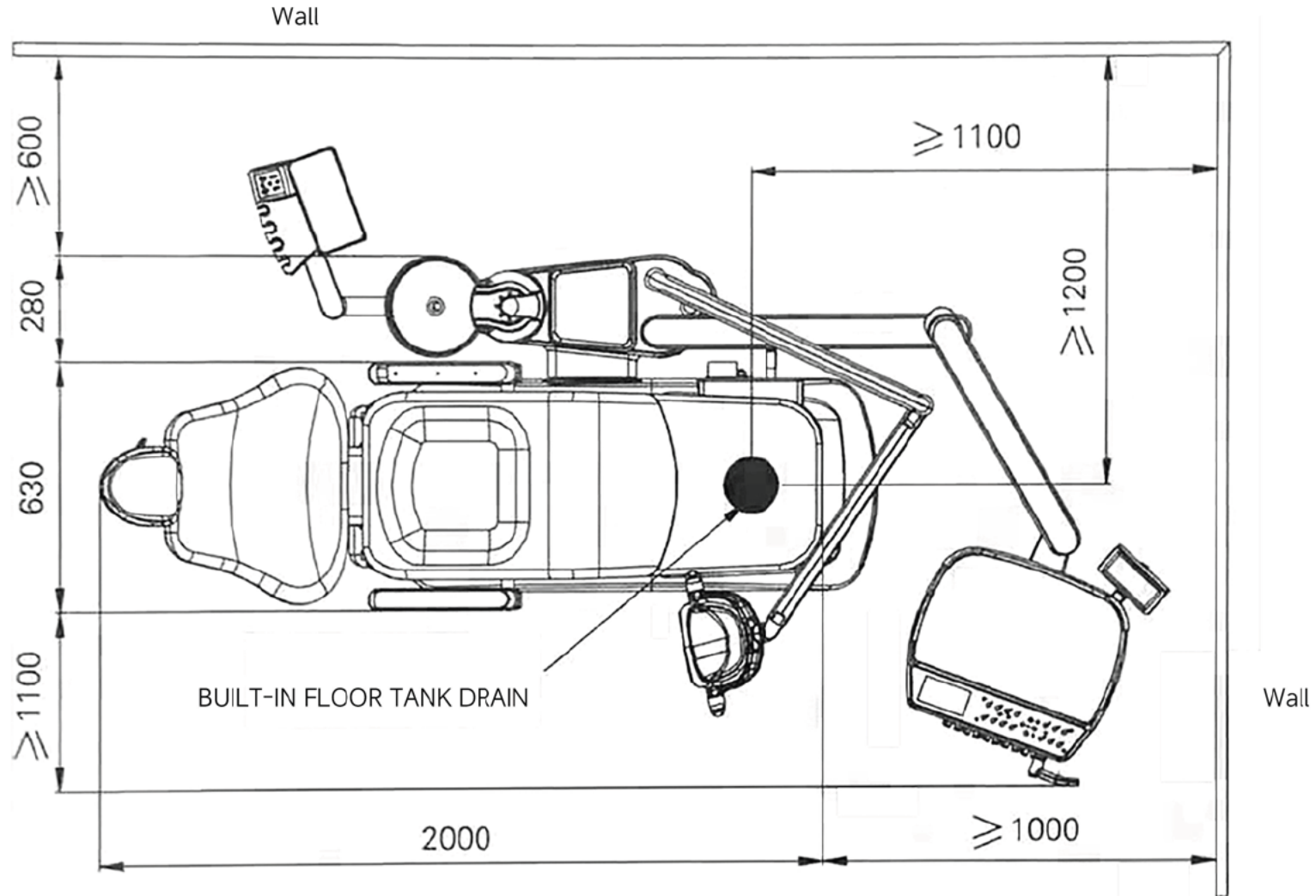

Installation Instructions

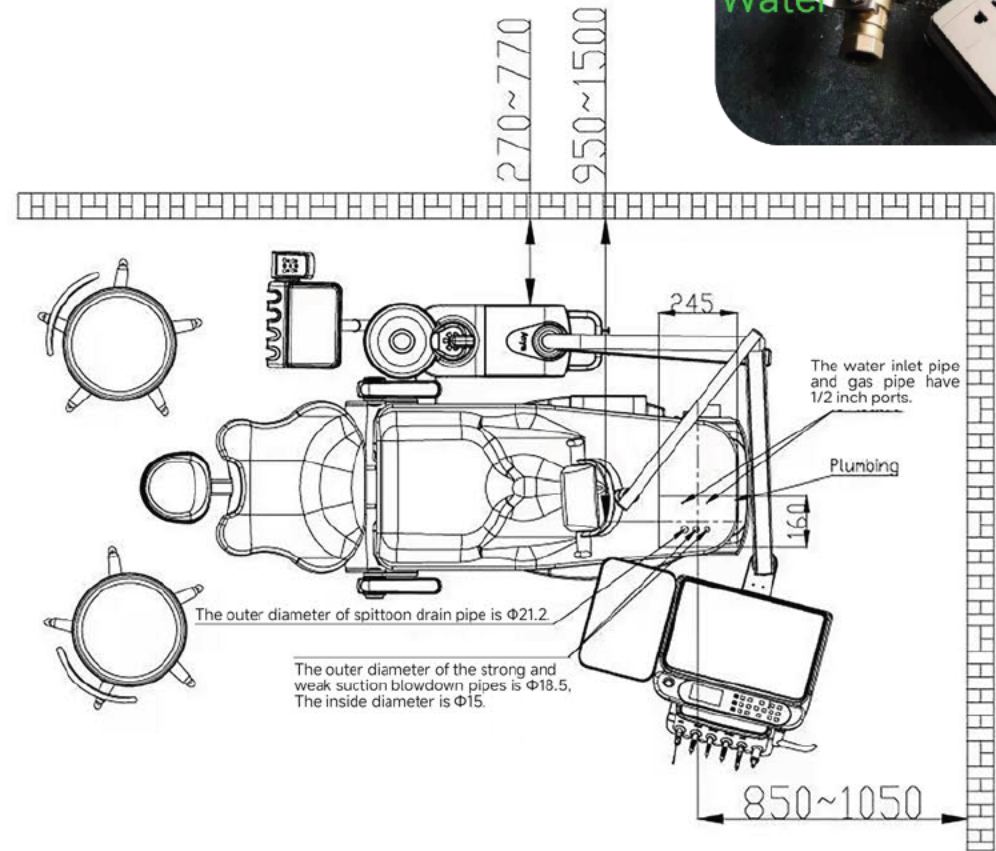
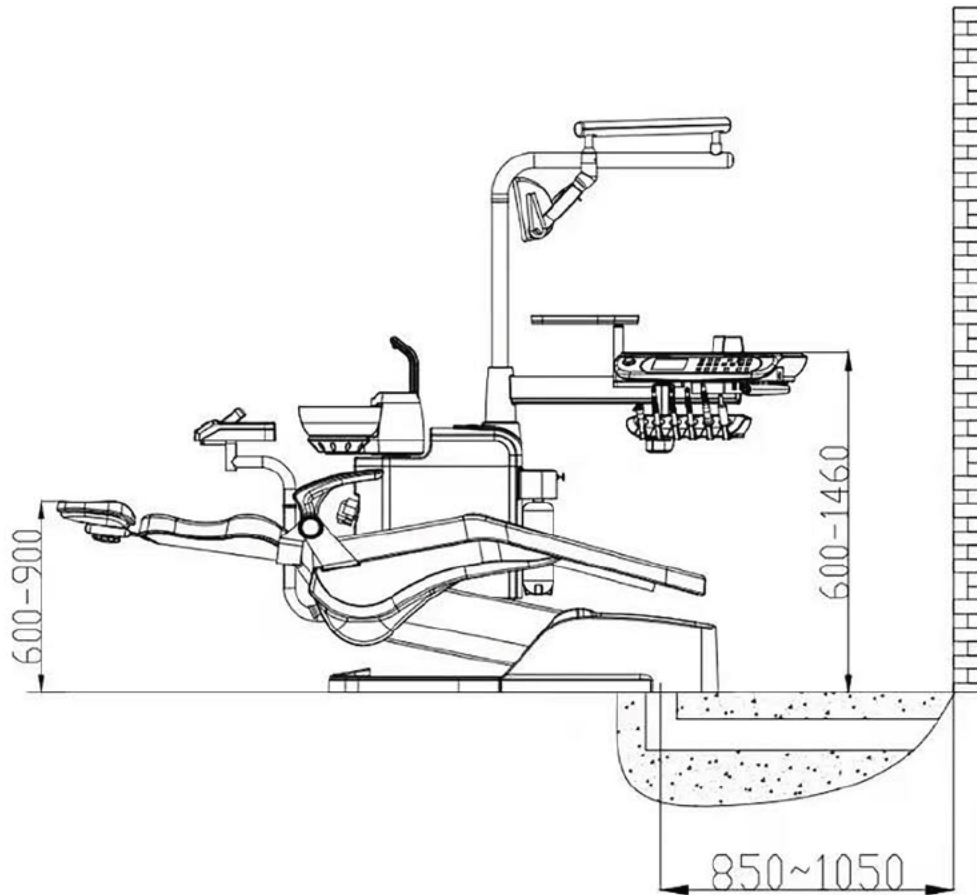

DENTAL LAMP





LED-FSF



LED-3-6



LED-3-4



LED-3-8

INTRODUCTION

1. The bracket is easily rotated and freely adjusted.
2. The handles are easy to disassemble.
3. Digital display the intensity and color temperatures.

4. Touch buttons to adjust the intensity and color temperatures.
5. Sensor switches to adjust the intensity.
6. All technical indicators are superior to international standards.

INTRODUCTION

1. The bracket is easily rotated and freely adjusted.
2. The handles are easy to disassemble.
3. Digital display the intensity and color temperatures.

4. Touch buttons to adjust the intensity and color temperatures
5. Sensor switches to adjust the intensity.
6. All technical indicators are superior to international standards.

Item No.	LED-FSF
Input Voltage	AC 12V-36V
Rated Power	20W
Light Intensity	7000Lux-45000Lux
Color temperature	4000-5500K
Pattern Size	80*160
Ra	≥90%
Shadow Less Performance	< Φ11mm
Intensity To Eyes	< 200Lux
Control Mode	Sensor / Touch
Interaction Range	20-80mm



Item No.	LED-3-8	LED-3-6	LED-3-4
Input Voltage	AC 12V-24V		
Rated Power	24W	18W	12W
Light Intensity	7000Lux-58000Lux	7000Lux-42000Lux	7000Lux-32000Lux
Color temperature	3750-5500K	3750-5500K	5500K
Pattern Size	80*160		
Ra	≥90%		
Shadow Less Performance	< Φ9mm		
Intensity To Eyes	< 200Lux		
Control Mode	Sensor / Touch		
Interaction Range	20-80mm		



LED-Z134

INTRODUCTION

1. Ring design concept, surrounding layout direct light source enhance the illumination brightness.
2. Side digital display, easy for users to check.
3. Side grasp type handles, easy to move, install and sterilize.

4. Three-axis supporting arm, flexible rotation.
5. Sensor switches to adjust illumination and color temperatures
6. Sliding to adjust the intensity.
7. All technical indicators are superior to international standards

Item No.	LED-Z134
Input Voltage	AC 12V-24V
Rated Power	55W
Light Intensity	7000Lux-120000Lux
Color temperature	4000-5700K
Pattern Size	80*160
Ra	≥92%
Shadow Less Performance	< Φ11mm
Intensity To Eyes	< 200Lux
Control Mode	Sensor / Touch
Interaction Range	20-80mm



LED-Z204

INTRODUCTION

1. Ring design concept, surrounding layout direct light source enhance the illumination brightness.
2. Side digital display, easy for users to check.
3. Side grasp type handles, easy to move, install and sterilize.

4. Three-axis supporting arm, flexible rotation.
5. Sensor switches to adjust illumination and color temperatures
6. Sliding to adjust the intensity.
7. All technical indicators are superior to international standards

Item No.	LED-Z204
Input Voltage	AC / DC 15-24V
Rated Power	30W
Light Intensity	30000Lux-90000Lux
Color temperature	4000-5500K
Pattern Size	60*50*28
Ra	≥92%
Shadow Less Performance	< Φ11mm
Intensity To Eyes	< 200Lux
Control Mode	Sensor / Touch
Interaction Range	120-900mm





LED-Z630

INTRODUCTION

1. Ring design concept, surrounding layout direct light source enhance the illumination brightness.
2. Side digital display, easy for users to check.
3. Side grasp type handles, easy to move, install and sterilize.

4. Three-axis supporting arm, flexible rotation.
5. Sensor switches to adjust illumination and color temperatures
6. Sliding to adjust the intensity.
7. All technical indicators are superior to international standards

Item No.	LED-Z630
Input Voltage	AC / DC 12-24V
Rated Power	25W
Light Intensity	8000Lux-80000Lux
Color temperature	3500-5500K
Pattern Size	80*160
Ra	≥92%
Shadow Less Performance	< Φ11mm
Intensity To Eyes	< 200Lux
Control Mode	Sensor / Touch
Interaction Range	120-900mm



LED-F001



LED-F002



LED-F003



LED-F004

Item No.	LED-3-8	LED-3-6	LED-3-4	
Input Voltage	AC 12V-24V			
Rated Power	20W	36W	24W	30W
Light Intensity	7000Lux-68000Lux	7000Lux-45000Lux	7000Lux-45000Lux	7000Lux-58000Lux
Color temperature	3500-5700K	3500K、5000K	3500K、5500K	3500K-5700K
Pattern Size	80*160			
Ra	≥90%			
Shadow Less Performance	< Φ7mm			
Intensity To Eyes	< 200Lux			
Control Mode	Sensor / Touch			
Interaction Range	20-80mm			



H1 Lamp Bracket Assembly

Connects to $\varnothing 50$ middle column, connector: $\varnothing 40$ / Connects to $\varnothing 45$ middle column, connector: $\varnothing 35$
Effective lamp extension length: 710 mm / Lamp balance vertical tilt angle: $\pm 40^\circ$ / Lamp head connector: $\varnothing 22 / \varnothing 26$



H2 Lamp Arm Component

Connects to $\varnothing 50$ column, adapter $\varnothing 40$; lamp rotating arm $\varnothing 50$ / Connects to $\varnothing 45$ column, adapter $\varnothing 35$; lamp rotating arm $\varnothing 45$
Effective height of lamp rotating arm: 705mm / Vertical movement angle of the lamp balance arm: $\pm 35^\circ$
Lamp interface diameter: $\varnothing 22 / \varnothing 26$



H2-1 Lamp Arm Component

Connects to $\varnothing 50$ column, adapter $\varnothing 40$; lamp rotating arm $\varnothing 50$ / Connects to $\varnothing 45$ column, adapter $\varnothing 35$; lamp rotating arm $\varnothing 45$
Effective height of lamp rotating arm: 705mm / Vertical movement angle of the lamp balance arm: $\pm 35^\circ$
Lamp interface diameter: $\varnothing 22 / \varnothing 26$



H3 Lamp Bracket Assembly

- Connects to $\varnothing 50$ middle column, connector: $\varnothing 40$; Lamp rotating tube: $\varnothing 50$
- Connects to $\varnothing 45$ middle column, connector: $\varnothing 35$; Lamp rotating tube: $\varnothing 45$
- Effective lamp extension length: 695 mm
- Lamp balance vertical tilt angle: $\pm 35^\circ$
- Lamp head connector: $\varnothing 22 / \varnothing 26$



H3-1 Lamp Bracket Assembly

- Connects to $\varnothing 50$ middle column, connector: $\varnothing 40$; Lamp rotating tube: $\varnothing 50$
- Connects to $\varnothing 45$ middle column, connector: $\varnothing 35$; Lamp rotating tube: $\varnothing 45$
- Effective lamp extension length: 695 mm
- Lamp balance vertical tilt angle: $\pm 35^\circ$
- Lamp head connector: $\varnothing 22 / \varnothing 26$

Shipping and Installation









Wooden-box Package

Maximize the protection of goods



Component List

For easy confirming

Component List			
No.	Name	QTY	Photo
1		1	
2		1	
3	A	1	
4		1	
5		1	
6	Ju	2	
7	F.	16	
8		2	

Tool Kit

Providing basic installation tools



Step by step Instruction

*Only simple installation required, the main body is ready for use

